

Max-Air Technology is pleased to introduce **THE SMART BEACON**

For applications where space minimization is a priority, and when the requirement for plug and play limit switches are desired, the new Max-Air SMART BEACON is the solution of choice.

The concept of the SMART BEACON is simple, powerfully effective, and designed to work with any manufacturer of inductive type sensors, such as IFM, Türck, and Pepperl + Fuchs.

The SMART BEACON was design with its dual purpose of clear visual indication and providing flexibility to configure its sensing heads for all types of rotary valve applications, including 2-way and 3-way multi-port valves.

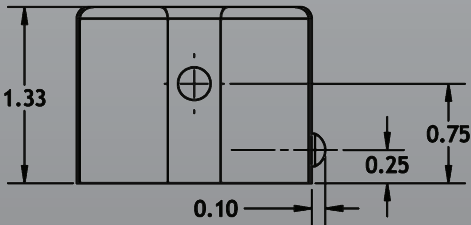
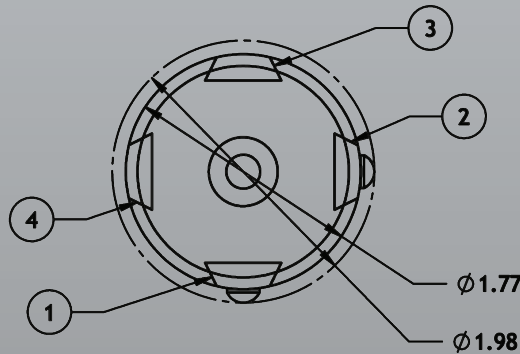
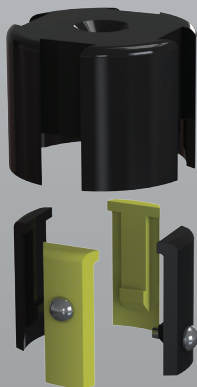

180° 3-Position Sensing Beacon

Other options available, call for details.

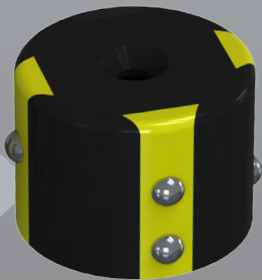

T-Port

Note: Sensing heads for proximity sensors are configurable for a variety of applications. Call 888.842.9998 for details.



Toll Free: 888.842.9998
Toll Free Fax: 866.842.3144
info@max-airtechnology.com
www.max-airtechnology.com

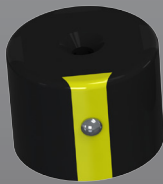

180°

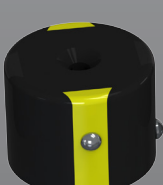

2-Way

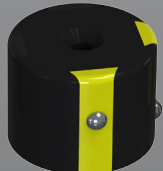

L-Port

Configuration	Insert Color			
	1	2	3	4
2-Way	●	●	●	●
L-Port	●	●	●	●
T-Port	●	●	●	●
180°	●	●	●	●